



**NB-Fi**

# **NB-Fi Evaluation Board**

**User Guide**



**August 2022**

---

## TABLE OF CONTENTS

Introduction	2
1. General Information about the NB-Fi Evaluation Board	3
1.1. Product Description	3
1.2. Technical Characteristics	4
1.3. Radio Signal Characteristics	4
1.4. Interfaces and Control	5
1.5. Access to the WAVIoT IoT Platform	8
1.6. NB-Fi Library and Demo Project	9
1.7. Technical Support	9
2. Working with the NB-Fi Evaluation Board	10
2.1. Checking the Evaluation Board Status	10
2.2. Quantitative parameters of signal quality	10
2.3. User Interface	10
2.4. Testing the NB-Fi Radio Channel	11
2.5. Evaluation Board Settings	12
2.6. Information about the NB-Fi Evaluation Board	15
3. Description of AT Commands	17
3.1. General Commands	17
3.2. Data Send/Receive Commands	19
3.3. NB-Fi Link Status Commands	20
3.4. NB-Fi Configuration Commands	23
4. Contact and Ordering Information	33

## INTRODUCTION

This User Guide is designed to make users acquainted with the operation of the NB-Fi Evaluation Board (hereinafter, the *Evaluation Board*).

This User Guide should be read before the Evaluation Board is operated.

The vendor reserves the right to make insignificant design modifications that do not affect the performance of the Evaluation Board and may not be reflected in this User Guide.

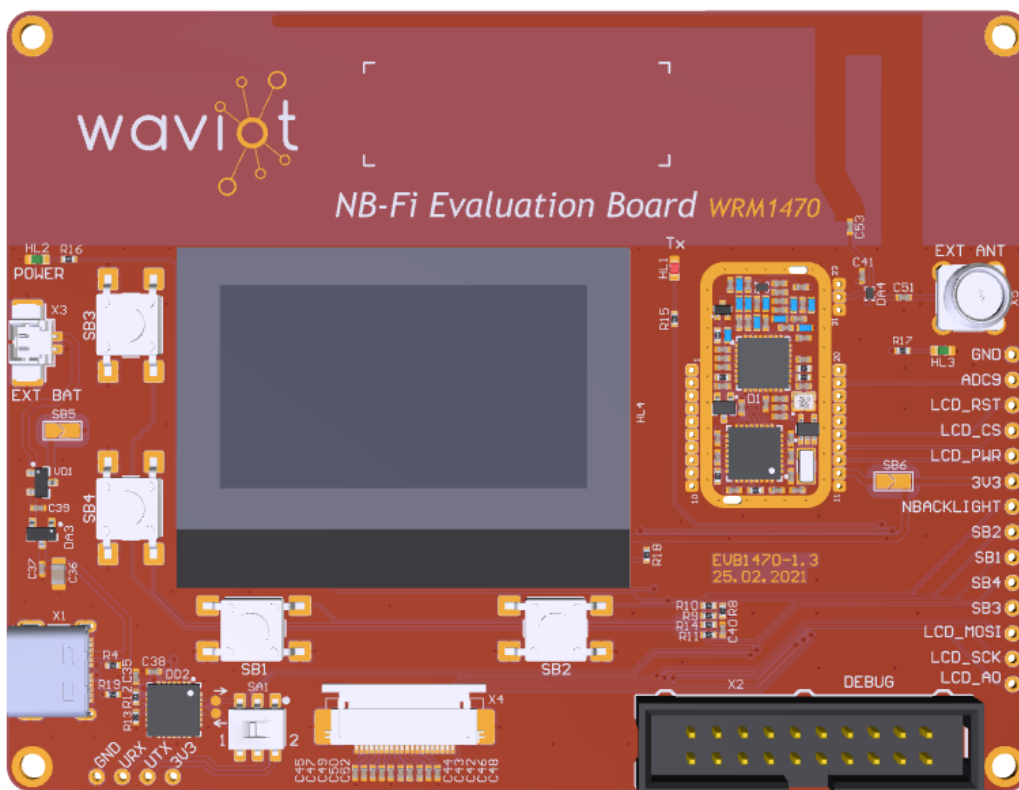

---

# 1. GENERAL INFORMATION ABOUT THE NB-FI EVALUATION BOARD

## 1.1. PRODUCT DESCRIPTION

The NB-Fi Evaluation Board product is a quick start tool to develop IoT applications using the NB-Fi communication protocol.

Using the user interface and the internal software, the Evaluation Board allows for testing of the operation of the NB-Fi communication protocol and the K5553BB015 transceiver, evaluation of the quantitative parameters of an NB-Fi link and installation of its own internal software onto the built-in microcontroller.

An NB-Fi specification is available in the Data Store section at the [www.nb-fi.org](http://www.nb-fi.org) website.

The Evaluation Board hardware includes a K5553BB015 NB-Fi transceiver and an STM32L071KBU6 microcontroller, a display, an SMA connector for installing an external antenna, debug contacts, tact switches for controlling the Evaluation Board, and a UART interface for working with AT commands, sending and receiving data and setting up the Evaluation Board.

Power can be supplied from a USB cable with a Type-C connector or from an external rechargeable battery.

A combination of the K5553BB015 NB-Fi transceiver and the STM32L071KBU6 MCU, together with auxiliary elements, is an example of implementing an NB-Fi radio module that can be used in multiple-purpose devices for receiving and transmitting data (marked on the Evaluation Board as *WRM1470*).

The Evaluation Board has a built-in printed antenna tuned for the 868.7 - 869.2 MHz frequency band.

An NB-Fi open-source library and a demo project for the NB-Fi Evaluation Board are published in the Data Store section at the [www.nb-fi.org](http://www.nb-fi.org) website. The developer may modify or reprogram the project if necessary, installing its own internal software onto the Evaluation Board.

The internal software of the Evaluation Board is initially installed by the vendor.

## 1.2. TECHNICAL CHARACTERISTICS

The main technical characteristics of the NB-Fi Evaluation Board are given in Table 1.1.

Table 1.1

Characteristic	Value
Interfaces	USB Type-C Debug Power Display SMA UART
Voltage range: - for the USB Type-C connector, V: - for the Power interface, V:	4.4 – 5.5 3.3 – 3.7
Power consumption, mA, not more than:	100
Battery supply voltage, V:	Up to 3.6
Overall dimensions (height × width × depth), mm, not more than:	100 × 75 × 10
Weight, kg, not more than:	0.2

## 1.3. RADIO SIGNAL CHARACTERISTICS

The Evaluation Board has a built-in printed antenna tuned for the 868.7 - 869.2 MHz frequency band. The maximum effective radiated power (ERP) of the signal is 25 mW. The ERP is regulated automatically, decreasing if it is excessive.

The Evaluation Board has an option to connect an external antenna through the SMA interface.

The main radio signal characteristics of the Evaluation Board are given in Table 1.2.

Table 1.2

Characteristic	Value
Wireless protocol	NB-Fi
Frequency of Uplink packets, MHz:	868.8 (by default) tunable frequency: 860-925
Frequency of Downlink packets, MHz:	869.15 (by default) tunable frequency: 860-925
Maximum effective radiated power (ERP), mW, not more than	25
<b>Characteristics of Uplink and Downlink packets</b>	
Modulation	DBPSK
Data rate, bps	50, 400, 3 200, 25 600

## 1.4. INTERFACES AND CONTROL

### 1.4.1. Interfaces

A description of interfaces of the NB-Fi Evaluation Board is given in Table 1.3.

Table 1.3

Interface	Designation	Description
USB Type-C	X1	A connector for power supply and connection of the Evaluation Board through a COM port
Debug	X2	A debugging interface for connection of a programming tool
Power	X3	An additional power supply connector
Display	X4	An interface for connection of a display
SMA	X5	A connector for connection of an external antenna
UART	-	An addition interface for connection to the serial port of the Evaluation Board

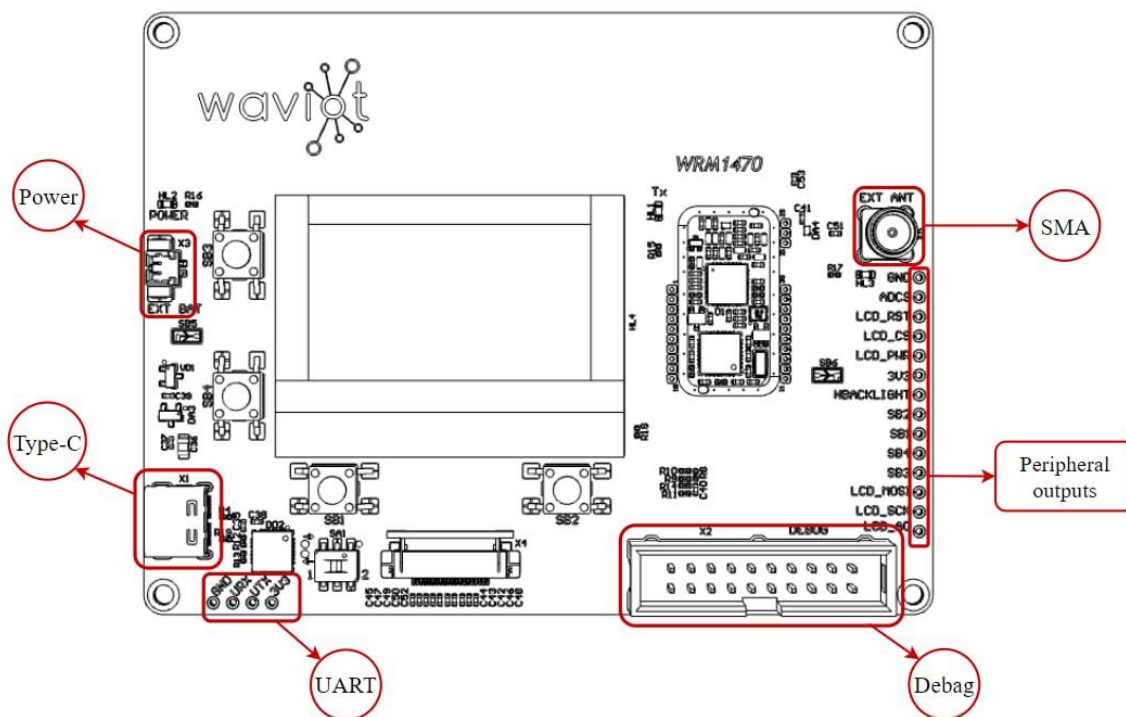

Figure 1. Interfaces of the Evaluation Board

### 1.4.2. Connection through the UART port

The serial port of the NB-Fi Evaluation Board is connected to the USB Type-C connector but can be switched to the UART interface, if necessary. To do so, it is necessary to connect (solder) the required device to the outputs of the UART interface (GND, URX, UTX, 3V3) according to the chart shown in Figure 2, and afterwards set the switch of the NB-Fi Evaluation Board to Position 2 (the designation of the switch on the Evaluation Board is SA1, see Figure 3).

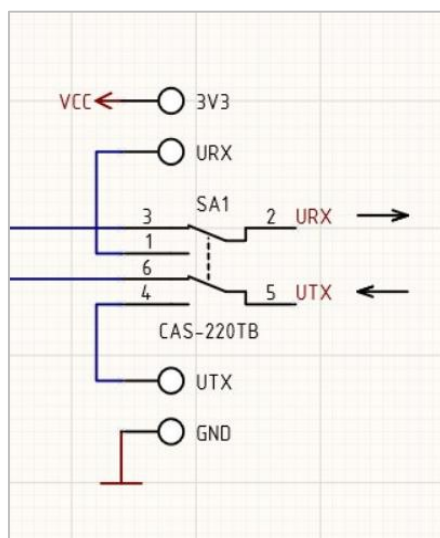

Figure 2. UART\_TX, UART\_RX Connection Chart

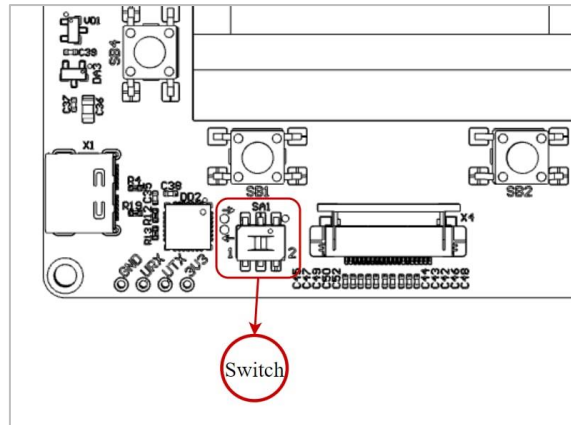

Figure 3. Switch location

### 1.4.3. Indication

The Evaluation Board is equipped with LED indicators shown in Figure 4 to provide visual prompts.

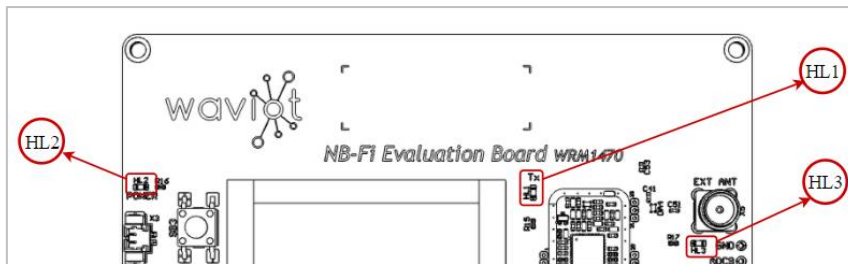

Figure 4. Indicators of the Evaluation Board

The HL2 LED indicator is lit if power is supplied to the NB-Fi Evaluation Board provided that it operates correctly.

The HL1 LED indicator is lit if the built-in printed antenna on NB-Fi Evaluation Board is in operation.

The HL3 LED indicator is lit if an external antenna connected via the SMA connector is in operation.

### 1.4.4. Control Buttons

The tact buttons connected to the NB-Fi Evaluation Board (see Figure 5) are used to browse menu items as well as select or cancel actions. A description of the functionality of the tact buttons is given in Table 1.4.



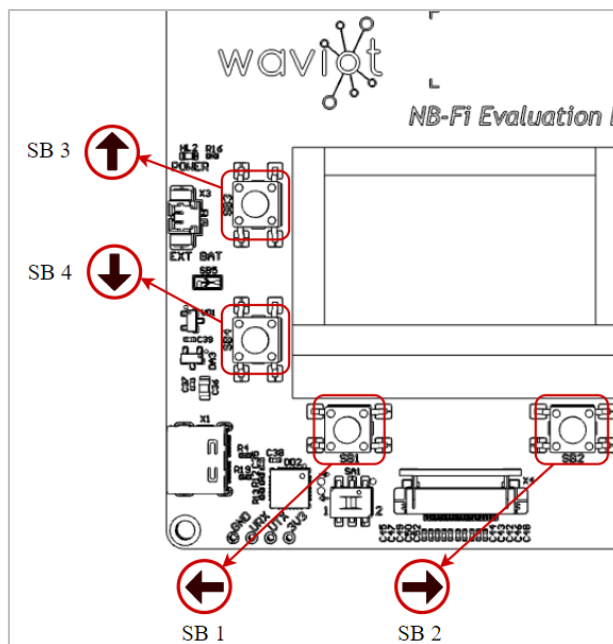

Figure 5. Tact buttons location

Table 1.4

Button	Designation	Function
SB1	«←» «Edit» «>»	Moves the cursor to the left or executes the actions shown on the display (“Enter”, “Edit”, “Switch”)
SB2	«→» «Back»	Moves the cursor to the right or executes the actions shown on the display (“Back”)
SB3	«↑»	Moves the cursor up
SB4	«↓»	Moves the cursor down

### 1.5. ACCESS TO THE WAVIoT IoT PLATFORM

In order to begin working on the WAVIoT IoT Platform, it is necessary to register in the WAVIoT IoT Platform authorization service at <https://auth.waviot.com>.

After the registration, in order to access messages of the NB-Fi Evaluation Board on the WAVIoT IoT platform, it is necessary to bind the NB-Fi Evaluation Board to your account at the <https://auth.waviot.com/?action=modem-show> page by pressing to the «Bind Device» button and entering a PIN code which provided in the Packing list supplied together with the NB-Fi Evaluation Board.

## 1.6. NB-Fi LIBRARY AND DEMO PROJECT

The NB-Fi library and the demo project with an example of implementing the NB-Fi Evaluation Board are available in the Data Store section at the [www.nb-fi.org](http://www.nb-fi.org) website.

## 1.7. TECHNICAL SUPPORT

If technical support is required, it may be contacted by e-mail at [support@waviot.com](mailto:support@waviot.com). In order to enable user identification, the technical support should be contacted from the e-mail linked to the account on the WAVIoT IoT platform.

Services relating to technical support, user consulting and product follow-up support are provided in the procedure determined by vendor.

An NB-Fi Base Station that can be supplied under a separate order may be required to receive NB-Fi signals from the NB-Fi Evaluation Board.

---

## 2. WORKING WITH THE NB-FI EVALUATION BOARD

### 2.1. CHECKING THE EVALUATION BOARD STATUS

In order to turn on the NB-Fi Evaluation Board, it is necessary to connect it to a DC power supply using a USB cable with a Type-C connector or connect it to an external rechargeable battery via the Power interface.

After the NB-Fi Evaluation Board is connected, the display should turn on and the respective LED indicators should be lit, and the Evaluation Board itself should connect to the WAVIoT IoT platform through a base station and begin to receive and transmit messages.

### 2.2. QUANTITATIVE PARAMETERS OF SIGNAL QUALITY

SNR and RSSI are quantitative parameters of signal quality. SNR and RSSI are shown on the messages page on the WAVIoT IoT platform and on the display of the NB-Fi Evaluation Board.

**RSSI** (Received Signal Strength Indicator) is the usable strength of radio waves, expressed in decibels between 0 dBm (strongest) and -150 dBm (weakest). Smaller negative numbers represent a cleaner/stronger signal. The RSSI determines the permeability of the environment for a signal (evaluates the influence of thick walls, etc.).

**SNR** (Signal to Noise Ratio) is a measure that compares the signal level to the amount of noise present in the medium of transmission. The larger the SNR is, the better it is. A stable signal can be considered with an average SNR of 30 dB or higher.

### 2.3. USER INTERFACE

Once the power is supplied to the NB-Fi Evaluation Board, the display becomes lit showing the main menu of the user interface. Using the user interface, messages can be received and transmitted, the signal level can be assessed, the signal transmission bitrates can be changed, some NB-Fi protocol settings can be defined, and a number of other actions described below can be taken.

The NB-Fi Evaluation Board is an “easy to use and understand” device thanks to its intuitive graphical interface.

The menu of the user interface of the NB-Fi Evaluation Board contains the following sections:

- **Tests**
  - NBFi TX
  - NBFi RX
  - RSSI
- **Settings**
- **Info**
  - NBFi quality
  - NBFi statistics
  - Device

## 2.4. TESTING THE NB-Fi RADIO CHANNEL

The **Tests** section provides the capability to transmit packets via a radio channel for its testing and receive information on the signal quality.

### 2.4.1. NBFi TX

The *NBFi TX* subsection includes the following functions:

- Send short packet
- Send long packet

The quantity of packets sent is specified in the *UL enqueued* line, as shown in Figure 6.

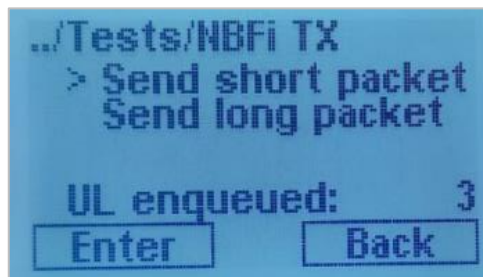

Figure 6.

### 2.4.2. NBFi RX

The *NBFi RX* subsection displays the following information about the last data packet received:

- The text of the Downlink packet in the HEX format
- The text of the Downlink packet in the ASCII format
- RSSI and SNR

### 2.4.3. RSSI

The *RSSI* subsection displays information about signal parameters (an example of displaying is shown in Figure 7). The following information is available in the subsection:

- RSSI – input signal power, dBm
- NOISE – noise, average RSSI value in the absence of a signal, dBm
- FREQ – frequency on which the NB-Fi Evaluation Board is currently receiving packets, Hz
- BITRATE – data rate, bps

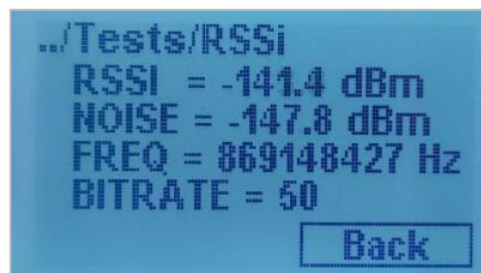

Figure 7.

### 2.5. EVALUATION BOARD SETTINGS

The **Settings** section allows for changing the main settings of the Evaluation Board (an example of displaying is shown in Figure 8).

In order to change the settings of the Evaluation Board, it is necessary to select the appropriate line (using the “↑” or “↓” switch buttons), turn on the edit mode by pressing the “Edit” button, and then switch (change) the mode using the “>” button. To save the settings, it is necessary to exit the edit mode by pressing the “Back” button.

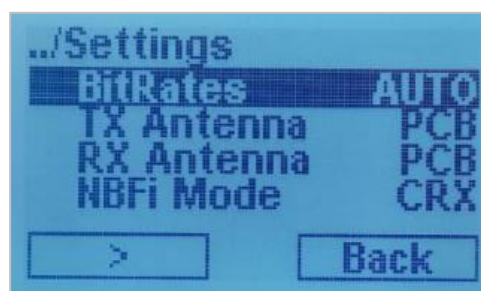

Figure 8.

### 2.5.1. BitRates

Setting up radio signal bitrates. The following setting options are available:

- AUTO
- 50
- 400
- 3200
- 25600

The AUTO mode is set by default and chooses bitrates automatically for Uplink and Downlink packets. Fixed bitrates (ranging from 50 to 25 600 bps) are set simultaneously for Uplink and Downlink packets.

### 2.5.2. TX Antenna

Setting up the TX antenna (transmission antenna) of the NB-Fi Evaluation Board. The following operation modes are available:

- PCB – the built-in antenna is enabled
- SMA – the external antenna is enabled

The standard operation mode of the Evaluation Board is the operation of the built-in printed antenna of the Evaluation Board.

In order to change antenna settings (use an external antenna), it is first necessary to connect the antenna to the SMA connector and then change the operation mode from “PCB” to “SMA”. When the SMA antenna is connected and set up correctly, the respective LED indicator should be lit on the Evaluation Board.

### 2.5.3. RX Antenna

Setting up the RX antenna (receiving antenna) of the NB-Fi Evaluation Board. The following operation modes are available:

- PCB – the built-in antenna is enabled
- SMA – the external antenna is enabled

The RX antenna is set up similarly to the TX antenna (see paragraph. 2.5.2).

## 2.5.4. NBFi Mode

Settings of the operation mode of the NB-Fi Evaluation Board. The following operation modes are available:

- CRX (*Continuous RX*) is the operation mode of the radio module of the Evaluation Board with permanently switched-on receiver, data is transmitted in both directions. The Evaluation Board transmits data if necessary, and is in the receive mode at all other times. Data can be sent to the Evaluation Board from the server at any time. All functions of the NB-Fi protocol operate in full. Data can be transmitted peer-to-peer. The CRX mode is used for devices with stationary power supply or for short-term use for the purpose of a peer-to-peer exchange.
- NRX (*No RX*) is the mode of data transmission from the device to the server only. The device transmits data if necessary, and the modem is in the standby mode at all other times. No resend of lost data or automatic optimal bitrate selection is supported.
- DRX (*Discontinuous RX*) is the mode of a short receive window for devices with the battery power supply, data is transmitted in both directions. The NB-Fi Evaluation Board transmits data if necessary and goes to the receive mode for a short period of time immediately after the end of transmission. The server buffers all queries for sending data to the Evaluation Board and transmits the data during opening of the time slot when the Evaluation Board goes to the receive mode. It can operate in the lost data resend mode and in the automatic bitrate selection mode.

## 2.5.5. HB Interval

The interval for sending Heartbeat packets (system packets of messages that contain information on the temperature, voltage, etc.) in minutes.

The mode set by default is to send packets each 5 minutes. Modes available for setting up:

- 1 – 10 minutes
- OFF (do not send)

## 2.5.6. Base Freqs

The selection of frequencies for Uplink and Downlink signals (frequency plan) from preset values for various countries (the frequency values are set in accordance with the frequency bands permitted for use in Europe, Argentina, Russia, India, Kazakhstan, and Uzbekistan, respectively).

- EU: ul\_freq=8681000000, dl\_freq=869550000
- AR: ul\_freq=916500000, dl\_freqs=902900000
- RU: ul\_freq = 868800000, dl\_freq=869150000
- IN: ul\_freq=866975000, dl\_freqs=865000000
- KZ: ul\_freq=864000000, dl\_freqs=863500000
- UZ: ul\_freq=458550000, dl\_freqs=453750000

Note: the central frequency values are specified. The frequency values set by default can be software changed.

## 2.6. INFORMATION ABOUT THE NB-FI EVALUATION BOARD

The **Info** section includes “*NB-Fi quality*”, “*NB-Fi statistics*” and “*Device*” subsections which contain basic diagnostic information about the radio signal and the status of the NB-Fi Evaluation Board.

### 2.6.1. NB-Fi quality

The *NB-Fi quality* subsection contains information about the NB-Fi radio signal (an example of displaying is shown in Figure 9). The following information is available in the subsection:

- Noise level, dBm
- SNR of the last Uplink packet (dB)
- SNR of the last Downlink packet (dB)
- Uplink signal bitrate, bps
- Downlink signal bitrate, bps



Figure 9.

### 2.6.2. NB-Fi statistics

The *NB-Fi statistics* section contains statistical information about the NB-Fi data transmission channel. The following information is available in the subsection:

- Quantity of queued packets
- Quantity of delivered packets



- Quantity of lost packets
- Total quantity of uplink packets
- Total quantity of downlink packets

An example of displaying statistical information is shown in Figure 10.



```
../Info/NBfi statistics
UL enqueued:      0
UL delivered:     33
UL lost:          6
UL total:         51
DL total:         24
```

Figure 10.

### 2.6.3. Device

The *Device* subsection contains basic information about the NB-Fi Evaluation Board. The following information is available in the subsection:

- ID – identification number of the device (number of the NB-Fi Evaluation Board)
- Time – time in the “hour:minutes:seconds” format (to be synchronized with the server upon data exchange)
- VCC – microcontroller supply voltage, V
- TEMP – microcontroller temperature, °C

An example of displaying information is shown in Figure 11.



```
../Info/Device info
ID:      8411400
Time:    10:01:33
VCC:     3.05V
TEMP:    29°C
Back
```

Figure 11.

### 3. DESCRIPTION OF AT COMMANDS

The NB-Fi Evaluation Board supports the operation and set up through both the user interface and AT commands. The AT commands allow for getting or setting the auxiliary parameters described in the NB-Fi standard.

Please read this User Guide and review the NB-Fi specification in advance before using AT commands.

In order to enter AT commands, it is necessary to connect the NB-Fi Evaluation Board to a personal computer (or another device that enables using AT commands) using a USB cable with a Type-C connector and select the respective virtual COM port in the terminal program.

#### 3.1. GENERAL COMMANDS

##### 3.1.1. AT+LIST: get list of AT commands

The command gets total list of AT commands supported.

Command	Input parameter	Return value	Return code
AT+LIST?	-	AT+LIST: get the list of AT commands supported	OK
AT+LIST or AT+LIST=?	-	List of AT commands	OK

##### 3.1.2. AT+FACTORY\_SETTINGS: reset NB-Fi settings to default values

The command resets NB-Fi settings to default values.

Command	Input parameter	Return value	Return code
AT+FACTORY_SETTINGS?	-	AT+FACTORY_SETTINGS: reset NB-Fi settings to factory defaults	OK
AT+FACTORY_SETTINGS	-	Run reset command	OK

### 3.1.3. AT+RESET: reset device

The command resets the NB-Fi Evaluation Board.

Command	Input parameter	Return value	Return code
AT+RESET?	-	AT+RESET: device reset	OK
AT+RESET	-	Run reset command	OK

### 3.1.4. AT+VCC: get device VCC value

The command returns NB-Fi Evaluation Board microcontroller supply voltage (VCC) value.

Command	Input parameter	Return value	Return code
AT+VCC?	-	AT+VCC: get VCC value	OK
AT+VCC or AT+VCC=?	-	VCC value (V)	OK
Example: AT+VCC=?	-	3.32	OK

### 3.1.5. AT+TEMP: get device temperature

The command returns NB-Fi Evaluation Board microcontroller temperature.

Command	Input parameter	Return value	Return code
AT+TEMP?	-	AT+TEMP: get device temperature	OK
AT+TEMP or AT+TEMP=?	-	Temperature value (°C)	OK
Example: AT+TEMP=?	-	29	OK

### 3.2. DATA SEND/RECEIVE COMMANDS

#### 3.2.1. AT+SEND: send data

The command adds a data packet to the send queue and returns the ID of the queued packet.

Command	Input parameter	Return value	Return code
AT+SEND?	-	AT+SEND: send hexadecimal data	OK
AT+SEND=<payload>	HEX string up to 240 bytes long	Queued packet ID	OK
Example: AT+SEND=	ABCDEF	1	OK

#### 3.2.2. AT+SEND\_STATUS: get the status of the queued send packet

The command returns the status of previously queued send data packet.

Command	Input parameter	Return value	Return code
AT+SEND_STATUS?	-	AT+SEND_STATUS: get the status of the sent packet	OK
AT+SEND_STATUS.<ID>=?	Queued packet ID	Queued packet status: 1 – queued 2 – in process 3 – delivered 4 – lost	OK, AT_PARAM_ERROR – packet ID not exists
Example: AT+SEND_STATUS.1=?	1	3	OK

#### 3.2.3. AT+RECEIVE: get the last received data packet

The command returns the payload (transport-level data) of last received data packet.

Command	Input parameter	Return value	Return code
AT+RECEIVE?	-	AT+RECEIVE: get the last received data packet	OK
AT+RECEIVE or AT+RECEIVE=?	-	HEX string up to 240 bytes long	OK, AT_EMPTY_ERROR – no data received yet
Example: AT+RECEIVE	-	ABCDEF	OK

### 3.3. NB-FI LINK STATUS COMMANDS

#### 3.3.1. AT+RSSI: get receiver RSSI level

The command returns receiver RSSI level.

Command	Input parameter	Return value	Return code
AT+RSSI?	-	AT+RSSI: get receiver RSSI current level	OK
AT+RSSI or AT+RSSI=?	-	RSSI level (dBm)	OK
Example: AT+RSSI=?	-	-125.3	OK

#### 3.3.2. AT+NOISE: get receiver Noise level

The command returns receiver Noise level.

Command	Input parameter	Return value	Return code
AT+NOISE?	-	AT+NOISE: get receiver noise current level	OK

Command	Input parameter	Return value	Return code
AT+NOISE or AT+NOISE=?	-	Noise level (dBm)	OK
Example: AT+NOISE=?	-	-145.7	OK

### 3.3.3. AT+LAST\_SNR: get last packet SNR level

The command returns last packet SNR level.

Command	Input parameter	Return value	Return code
AT+LAST_SNR?	-	AT+LAST_SNR: get last received packet SNR level	OK
AT+LAST_SNR or AT+LAST_SNR=?	-	SNR level (dB)	OK
Example: AT+LAST_SNR=?	-	45	OK

### 3.3.4. AT+LAST\_RSSI: get last packet RSSI level

The command returns last packet RSSI level.

Command	Input parameter	Return value	Return code
AT+LAST_RSSI?	-	AT+LAST_RSSI: get last received packet RSSI level	OK
AT+LAST_RSSI or AT+LAST_RSSI=?	-	RSSI level (dBm)	OK
Example: AT+LAST_RSSI=?	-	-101	OK

### 3.3.5. AT+AVER\_UL\_SNR: get average uplink (TX) SNR level

The command returns average uplink (TX) SNR level.

Command	Input parameter	Return value	Return code
AT+AVER_UL_SNR?	-	AT+AVER_UL_SNR: get average uplink SNR level	OK
AT+AVER_UL_SNR or AT+AVER_UL_SNR=?	-	Average SNR level (dB)	OK
Example: AT+AVER_UL_SNR=?	-	17	OK

### 3.3.6. AT+AVER\_DL\_SNR: get average downlink (RX) SNR level

The command returns average downlink (RX) SNR level.

Command	Input parameter	Return value	Return code
AT+AVER_DL_SNR?	-	AT+AVER_DL_SNR: get average downlink SNR level	OK
AT+AVER_DL_SNR or AT+AVER_DL_SNR=?	-	Average SNR level (dB)	OK
Example: AT+AVER_DL_SNR=?	-	26	OK

### 3.4. NB-Fi CONFIGURATION COMMANDS

#### 3.4.1. AT+ID: get device ID

The command returns the device ID.

Command	Input parameter	Return value	Return code
AT+ID?	-	AT+ID: get the device ID	OK
AT+ID or AT+ID=?	-	Device ID	OK
Example: AT+ID=?	-	8158651	OK

#### 3.4.2. AT+KEY: get device master key

The command returns the device master key.

Command	Input parameter	Return value	Return code
AT+KEY?	-	AT+KEY: get the device master key	OK
AT+KEY or AT+KEY=?	-	Device master key	OK
Example: AT+KEY=?	-	48835B4ABFE99BC307 3257C51D64005A67439 32DF6743D7E59C60001 21F049A7	OK

#### 3.4.3. AT+MODE: get/set the NB-Fi mode

The command returns information on the current settings of the NB-Fi protocol transport-level operation mode or allows for setting it.



Command	Input parameter	Return value	Return code
AT+MODE?	-	AT+MODE: get/set the NB-Fi mode (0 – NRX, 1 – DRX, 2 – CRX, 3 – OFF)	OK
AT+MODE or AT+MODE=?	-	Current NB-Fi protocol operation mode: 0 – NRX 1 – DRX 2 – CRX 4 – OFF	OK
AT+MODE=<mode>	0, 1, 2, 4	-	OK
Example: AT+MODE=1	1	-	OK

Note: Setting of the parameter resets RX and TX bitrates to initial (default) values.

#### 3.4.4. AT+TX\_PHY: get/set the TX\_PHY parameter

The command returns information on the NB-Fi TX\_PHY\_CHANNEL parameter of the transmitter (the parameter defining the type and bitrate of packets when sending Uplink packets) or allows for setting the default value of the TX\_PHY\_CHANNEL parameter.

Command	Input parameter	Return value	Return code
AT+TX_PHY?	-	AT+TX_PHY: get/set the tx phy default value	OK
AT+TX_PHY or AT+TX_PHY=?	-	Current TX_PHY_CHANNEL value	OK
AT+TX_PHY=<value>	Number in the range of 0 – 255	-	OK
Example: AT+TX_PHY=?	-	33	OK

Note: Setting of the parameter resets RX and TX bitrates to initial (default) values.

### 3.4.5. AT+RX\_PHY: get/set the RX\_PHY parameter

The command returns information on the NB-Fi RX\_PHY\_CHANNEL parameter of the receiver (the parameter defining the type and bitrate of packets when receiving Downlink packets) or allows for setting the default value of the RX\_PHY\_CHANNEL parameter.

Command	Input parameter	Return value	Return code
AT+RX_PHY?	-	AT+RX_PHY: get/set the rx phy default value	OK
AT+RX_PHY or AT+RX_PHY=?	-	Current RX_PHY_CHANNEL value	OK
AT+RX_PHY=<value>	Number in the range of 0 – 255	-	OK
Example: AT+RX_PHY=?	-	13	OK

Note: Setting of the parameter resets RX and TX bitrates to initial (default) values.

### 3.4.6. AT+RETRIES: get/set the number of send retries

The command returns information on the current settings of the maximum number of packet send retries during one data send session or allows for setting this value.

Command	Input parameter	Return value	Return code
AT+RETRIES?	-	AT+RETRIES: get/set the number of send retries	OK
AT+RETRIES or AT+RETRIES=?	-	Current TX packet send retries value. Lowest 4 bits – number of retries for all bitrate types, highest 4 bits – number of additional retries for high bitrates	OK

Command	Input parameter	Return value	Return code
AT+RETRIES=<value>	Number in the range of 0 – 255	-	OK
Example: AT+RETRIES=?	-	130	OK

Note: Setting of the parameter resets RX and TX bitrates to initial (default) values.

### 3.4.7. AT+TX\_ANT: get/set the TX antenna type

The command returns information on the current setting of the TX antenna type or allows for setting the TX antenna type. Possible value options: 0: PCB (built-in printed antenna), 1: SMA (external antenna).

Command	Input parameter	Return value	Return code
AT+TX_ANT?	-	AT+TX_ANT: get/set the tx antenna type (0 – PCB, 1 – SMA)	OK
AT+TX_ANT or AT+TX_ANT=?	-	Current TX antenna mode: (0 – PCB, 1 – SMA)	OK
AT+TX_ANT=<value>	0 or 1	-	OK
Example: AT+TX_ANT=?	-	0	OK

Note: Setting of the parameter resets RX and TX bitrates to initial (default) values.

### 3.4.8. AT+RX\_ANT: get/set the RX antenna type

The command returns information on the current setting of the RX antenna type or allows for setting the RX antenna type. Possible value options: 0: PCB (built-in printed antenna), 1: SMA (external antenna).

Command	Input parameter	Return value	Return code
AT+RX_ANT?	-	AT+RX_ANT: get/set the rx antenna type (0 – PCB, 1 – SMA)	OK
AT+RX_ANT or AT+RX_ANT=?	-	Current RX antenna mode: (0 – PCB, 1 – SMA)	OK
AT+RX_ANT=<value>	0 or 1	-	OK
Example: AT+RX_ANT=?	-	0	OK

Note: Setting of the parameter resets RX and TX bitrates to initial (default) values.

### 3.4.9. AT+MAX\_POWER: get/set the TX output max power

The command returns the current value of the TX max output power or allows for setting this value.

Command	Input parameter	Return value	Return code
AT+MAX_POWER?	-	AT+MAX_POWER: get/set the tx max power (dBm)	OK
AT+MAX_POWER or AT+MAX_POWER=?	-	Current TX max power value (dBm)	OK
AT+MAX_POWER=<value>	Value in dBm	-	OK
Example: AT+MAX_POWER=?	-	15	OK

Note: Setting of the parameter resets RX and TX bitrates to initial (default) values.

### 3.4.10. AT+HB\_INTERVAL: get/set the heartbeats sending interval

The command returns information on the current settings of the Heartbeat packet send interval (information on device operation parameters) or allows for setting it. It is set in seconds for the CRX mode and in minutes for the NRX/DRX modes.

Command	Input parameter	Return value	Return code
AT+HB_INTERVAL?	-	AT+HB_INTERVAL: get/set the heartbeat interval (sec in CRX, min in NRX/DRX)	OK
AT+HB_INTERVAL or AT+HB_INTERVAL=?	-		OK
AT+ HB_INTERVAL=<value>	Number in the range of 0 – 65535. 0 – do not send Heartbeat packets.	-	OK
Example: AT+HB_INTERVAL=?	-	300	OK

Note: Setting of the parameter resets RX and TX bitrates to initial (default) values.

### 3.4.11. AT+FLAGS: get/set the NB-Fi additional flags

The command returns information on NB-Fi additional flags (parameters that control specific protocol functions grouped as a bit mask) or allows for setting additional flag values. Active flag value: 1. Byte sequence in the parameter field: lowest bit first.

Command	Input parameter	Return value	Return code
AT+FLAGS?	-	AT+FLAGS: get/set the NB-Fi flags bitmap	OK
AT+FLAGS or AT+FLAGS =?	-	Current NB-Fi additional flags bitmap	OK

Command	Input parameter	Return value	Return code
AT+ FLAGS=<value>	Number in the range of 0 – 65535	-	OK
Example: AT+FLAGS=?	-	0	OK

Note: Setting of the parameter resets RX and TX bitrates to initial (default) values.

### 3.4.12. AT+UL\_BASE\_FREQ: get/set the uplink (TX) base frequency

The command returns the current value of the UL\_BASE\_FREQ base frequency (the parameter corresponds to the base frequency used in calculating the frequency on which the data is sent) or allows for setting it.

Command	Input parameter	Return value	Return code
AT+UL_BASE_FREQ?	-	AT+UL_BASE_FREQ: get/set the uplink base frequency (Hz)	OK
AT+UL_BASE_FREQ or AT+UL_BASE_FREQ=?	-	Current NB-Fi uplink base frequency (Hz)	OK
AT+ UL_BASE_FREQ=<value>	Value in Hz	-	OK
Example: AT+UL_BASE_FREQ=?	-	868800000	OK

Note: Setting of the parameter resets RX and TX bitrates to initial (default) values.

### 3.4.13. AT+DL\_BASE\_FREQ: get/set the downlink (RX) base frequency

The command returns the current value of the DL\_BASE\_FREQ base frequency (the parameter corresponds to the base frequency used in calculating the frequency on which the data is received) or allows for setting it.

Command	Input parameter	Return value	Return code
AT+DL_BASE_FREQ?	-	AT+DL_BASE_FREQ: get/set the downlink base frequency (Hz)	OK
AT+DL_BASE_FREQ or AT+DL_BASE_FREQ=?	-	Current NB-Fi downlink base frequency (Hz)	OK
AT+DL_BASE_FREQ=<value>	Value in Hz	-	OK
Example: AT+DL_BASE_FREQ=?	-	869150000	OK

Note: Setting of the parameter resets RX and TX bitrates to initial (default) values.

#### 3.4.14. AT+FPLAN: get/set frequency plan

The command returns information on the current value of the FPLAN parameter or allows for setting it. The FPLAN parameter defines values of operating frequencies for Uplink and Downlink signals. Parameter type: uint16\_t. Byte sequence in the field: highest bit first.

Command	Input parameter	Return value	Return code
AT+FPLAN?	-	AT+FPLAN: get/set the NB-Fi frequency plan	OK
AT+FPLAN or AT+FPLAN=?	-	Current NB-Fi frequency plan	OK
AT+FPLAN=<value>		-	OK
Example: AT+FPLAN=?	-	24576	OK

Note: Setting of the parameter resets RX and TX bitrates to initial (default) values.

**3.4.15. AT+SR\_SERVER\_ID: get/set the NB-Fi short-range server ID**

The command returns the current NB-Fi SERVER\_ID (NB-Fi short-range server ID with which data is exchanged) or allows for setting it. Parameter type: uint16\_t. Byte sequence in this field: highest bit first.

Command	Input parameter	Return value	Return code
AT+SR_SERVER_ID?	-	AT+SR_SERVER_ID: get/set the short-range server device ID	OK
AT+SR_SERVER_ID or AT+SR_SERVER_ID=?	-	Short-range server device ID	OK
AT+ SR_SERVER_ID=<value>		-	OK
Example: AT+SR_SERVER_ID=?	-	8567831	OK

**3.4.16. AT+SR\_SERVER\_KEY: get/set the NB-Fi short-range server master key**

The command returns the NB-Fi short-range server master key or allows for setting a new master key.

Command	Input parameter	Return value	Return code
AT+SR_SERVER_KEY?	-	AT+SR_SERVER_KEY: get/set the short-range server device master key	OK
AT+SR_SERVER_KEY or AT+SR_SERVER_KEY=?	-	Short-range server device master key	OK
AT+ SR_SERVER_KEY= <value>		-	OK
Example: AT+SR_SERVER_KEY=?	-	48835B4ABFE99BC307 3257C21D64005A67439 32DF6743E7E59C60001 21F049A7	OK



### 3.4.17. AT+SR\_MODE: get/set short-range mode

The command returns information on the current short-range mode status or allows for setting it.

Command	Input parameter	Return value	Return code
AT+SR_MODE?	-	AT+SR_MODE: get/set the short-range mode (0 – disabled, 1 – server, 2 – client)	OK
AT+SR_MODE or AT+SR_MODE=?	-	Short-range mode 0 – disabled 1 – server 2 – client	OK
AT+SR_MODE=<value>		-	OK
Example: AT+SR_MODE=?	-	1	OK

---

## 4. CONTACT AND ORDERING INFORMATION

**WAVIoT Integrated Systems, LLC**

**United States of America**

Business ID: DL133522

**E-MAIL: [SALES@WAVIOT.COM](mailto:SALES@WAVIOT.COM)**

The NB-Fi Evaluation Board is manufactured by Telematics Solutions, LLC.

---

All rights reserved. NB-Fi and WAVIoT are trademarks of WAVIoT Integrated Systems, LLC or its subsidiaries in the United States and/or other countries. WAVIoT Integrated Systems, LLC owns the rights to a number of patents, trademarks, copyrights, trade secrets, and other intellectual property.

Reproduction in whole or in part is prohibited without the prior written consent of the copyright owner. The information presented in this document does not form part of any quotation or contract, is believed to be accurate and reliable and may be changed without notice. No liability will be accepted by the publisher for any consequence of its use. Publication thereof does not convey nor imply any license under patent or other industrial or intellectual property rights.

WAVIoT Integrated Systems, LLC assumes no responsibility or liability whatsoever for any failure or unexpected operation resulting from misuse, neglect improper installation, repair or improper handling or unusual physical or electrical stress including, but not limited to, exposure to parameters beyond the specified maximum ratings or operation outside the specified range.

WAVIoT products are not designed, intended, authorized or warranted to be suitable for use as a critical component in life-support applications, devices or systems or other critical applications. Inclusion of WAVIoT products in such applications is understood to be undertaken solely at the customer's own risk. Should a customer purchase or use WAVIoT products for any such unauthorized application, the customer shall indemnify and hold WAVIoT Integrated Systems, LLC and its officers, employees, subsidiaries, affiliates, and distributors harmless against all claims, costs damages and attorney fees which could arise.

---